

ANTENNAS | PUCK-4 SERIES

3-IN-1 TRANSPORTATION & IOT/M2M ANTENNA

617 – 4200 MHz; 2X2 LTE (MIMO), 6 dBi; GPS/GLONASS, 21 dBi

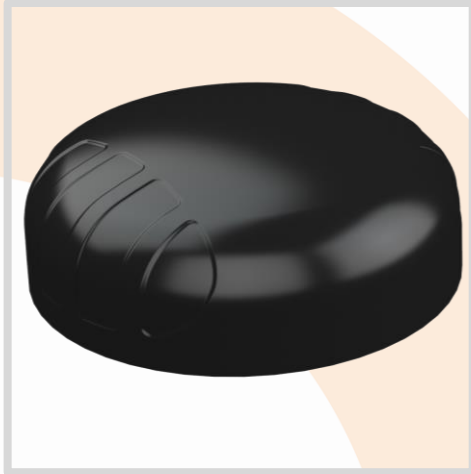

					
617 – 960 MHz 1427 – 1517 MHz 1710 – 2700 MHz 3400 – 4200 MHz	LTE: 6 dBi GPS: 21 dBi	2X2 MIMO	Omni-Directional	4G LTE	5G
					
Machine to Machine	CBRS Band	GPS Included	IP69K	-40°C to +80°C	Fire Resistant



APPLICATION AREAS

- 3-in-1 high performance multi frequency antenna
- 2G/3G/4G/LTE/5G antenna
- LTE (2x2 MIMO) & GPS/GLONASS
- Wideband – covers wide frequency band, incl. 3.5 GHz CBRS band
- Robust, vandal resistant and waterproof (IP69K rating)
- Ideal for transportation, marine and IoT/M2M use
- Ultra-versatile mounting options for easy installation

Product Overview

Poynting's new PUCK range offers a small profile antenna for use in the IoT/M2M, Smart Meter, Smart Utilities, Transportation, Marine and the Agricultural/Farming markets. The PUCK-4 consists of a 3-in-1 antenna system within a single housing, featuring 2X2 MIMO LTE, and GPS/GLONASS. The 2X2 Cellular MIMO antennas (for 2G/3G/4G) cover the 617 to 4200 MHz band, this includes the most popular international LTE bands. The third antenna is a high-performance active GPS/GLONASS system operating at temperatures as low as -40°C. The PUCK exceeds the performance of many competitors due to the attention to design of this high-performance antenna. The radiation patterns of all radiating elements provide an excellent balance between omnidirectionality, pattern diversity and good radiation abilities at the desired elevation, which is often overlooked in such a small size antenna. Despite its small size, this antenna provides excellent performance especially at the higher frequency bands, where performance is critical for LTE throughput and connection stability. This antenna is designed so that both the LTE ports are connected to the router/device to ensure the best performance. Please see other derivatives of the PUCK range that are more suitable for a SISO application.

Features

- Small & Low-profile (Ø100mm x 36mm (h))
- Careful mechanical design provides ruggedness, corrosion, water and dust resistance (IP69K)
- Fire Resistant
- UV Stable Enclosure
- 5G Ready – includes the 3.2 GHz to 3.8 GHz CBRS Band
- Easy installation; multi-implementation options available:
 - Spigot Mount
 - Magnetic Mount
 - Adhesive Tape Mount
 - Bracket Mount

Application Areas

- Smart utilities: Smart Power, Gas & Water Metering
- Smart Buildings: Climate control, access control, security, irrigation
- Industrial factory automation, robotic machinery and other M2M systems
- Digital Signage
- Warehouses & Logistic systems
- Transport (Busses, Utility & Public Safety)
- Mining Vehicles & Machinery communications, telemetry and automation (M2M & IoT)
- Agricultural machinery
- Marine: small boats, yachts near to coastlines or inner waters



Frequency Bands

The PUCK-4 is an omni-directional antenna that works from 617 – 960 MHz | 1427 – 1517 MHz | 1710 – 2700 MHz | and | 3400 – 4200 MHz |

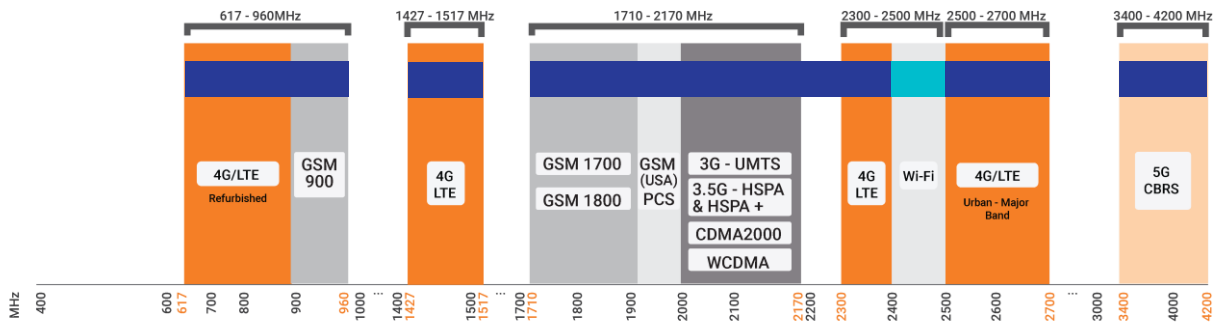

Indicates the LTE bands on which PUCK-4 works

Indicates the WI-FI bands on which PUCK-4 works

Antenna Overview

	 LTE	 GPS
Ports	1 & 2	3
SISO / MIMO	2x2 MIMO	N/A
Frequency Bands	617 – 4200 MHz	1575.42 MHz / 1600 MHz
Peak Gain	6 dBi	21 dBi
Coax Cable Type	Twin HDF 195	RTK-031
Coax Cable Length	2m	2m
Connector Type	SMA (M)	SMA (M)

**The coax cable & connector are factory mounted to the antenna*

Electrical Specification

Frequency Bands:	617 – 960 MHz 1427 – 1517 MHz 1710 – 2700 MHz 3400 – 4200 MHz
Gain (Max) Port 1 & 2:	0 dBi @ 617-960 MHz 1 dBi @ 1427-1527 MHz 5 dBi @ 1710-2700 MHz 6 dBi @ 3400-4200 MHz
VSWR Port 1 & 2:	≤2.5:1 Across 90% of the bands
Feed Power Handling:	10 W
Input Impedance:	50 Ohm (nominal)
Polarisation:	Linear Vertical
Coax Cable Loss:	0.56 dB/m @ 900 MHz 0.71 dB/m @ 1500 MHz 0.785 dB/m @ 1800 MHz 0.91 dB/m @ 2400 MHz 1.2 dB/m @ 3000 MHz
DC Short:	Yes

GPS/Glonass Antenna Electrical Specifications

Frequency Range (GPS):	1575.42MHz/1600MHz
Gain (Max):	21+/-2dBi
VSWR:	≤1.5:1
DC Voltage:	2.7-3.3 V
DC Current:	5-15mA
Noise Figure:	≤1.5 dB
Nominal Impedance:	50 Ω
Polarisation:	RHCP
Filter Out Band Attenuation:	12dB Min f0+50MHz, 16dBi Min f0-50MHz
Voltage:	2.7 - 3.3V
Max. Power-W:	50
Coax cable loss:	0.71 dB/m @ 1500 MHz

Product Box Contents

Antenna:	A-PUCK-0004-V1-01
Mounting Bracket:	Ø20 Threaded Spigots (Up to 60mm clamping thickness), Adhesive Surface Mounting & Magnetic Mount

Ordering Information

Commercial name:	PUCK-4
Order product code:	A-PUCK-0004-V1-01
EAN number:	6009880915224
EU Homologation Number:	E1*10R06/01*9551*00

Mechanical Specification

Product Dimensions	Ø99.3 mm x 36 mm
Packaged Dimensions:	150 mm x 150mm x 120mm
Weight:	0.426kg
Packaged Weight:	0.557kg
Radome Material	PC+ABS (Halogen free)
Radome Colour	Black
Mounting Type:	Ø20 Threaded Spigot, Pole, Wall, Surface and Magnetic mount

Environmental Specifications, Certification & Approvals

Wind Survival:	≤220 km/h
Temperature Range (Operating):	-40°C to +80°C
Environmental Conditions:	Outdoor/Indoor
Water Ingress Protection Ratio/Standard:	IP69K
Salt Spray:	MIL-STD 810G/ASTM B117
Operating Relative Humidity:	Up to 98%
Storage Humidity:	5% to 95% - non-condensing
Storage Temperature:	-40°C to +80°C
Enclosure Flammability Rating:	UL 94-HB
Impact Resistance:	IK 10
Product Safety & Environmental:	Complies with CE and RoHS standards



Antenna Performance Plots

VSWR

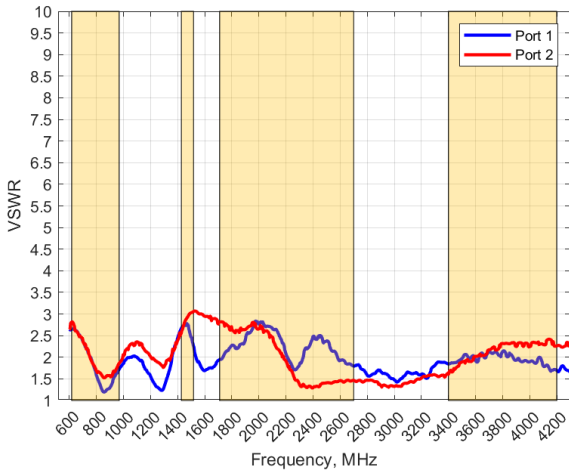

GAIN (EXCLUDING CABLE LOSS)

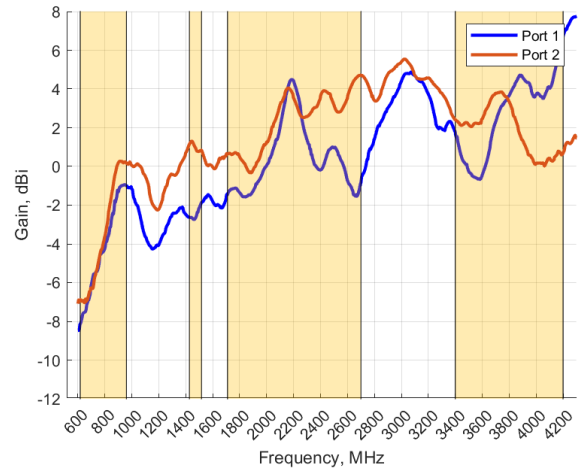

Voltage Standing Wave Ratio (VSWR)*

VSWR is a measure of how efficiently radio-frequency power is transmitted from a power source, through a transmission line, into a load. In an ideal system, 100% of the energy is transmitted which corresponds to a VSWR of 1:1.

The PUCK-4 delivers superior performance across all bands with a VSWR of $\leq 2.5:1$ or better across 90% of the bands.

**Measured with 2m low loss cable, 650 x 650 mm ground plane, and unused ports terminated with 50Ω load.*

Gain* in dBi

6 dBi is the peak gain across all bands from 617 – 4200 MHz

Gain @ 617 – 960 MHz:	0 dBi
Gain @ 1427 – 1517 MHz:	1 dBi
Gain @ 1710 – 2700 MHz:	5 dBi
Gain @ 3400 – 4200 MHz:	6 dBi

**Antenna gain measured with polarisation aligned standard antenna*

Technical Drawings

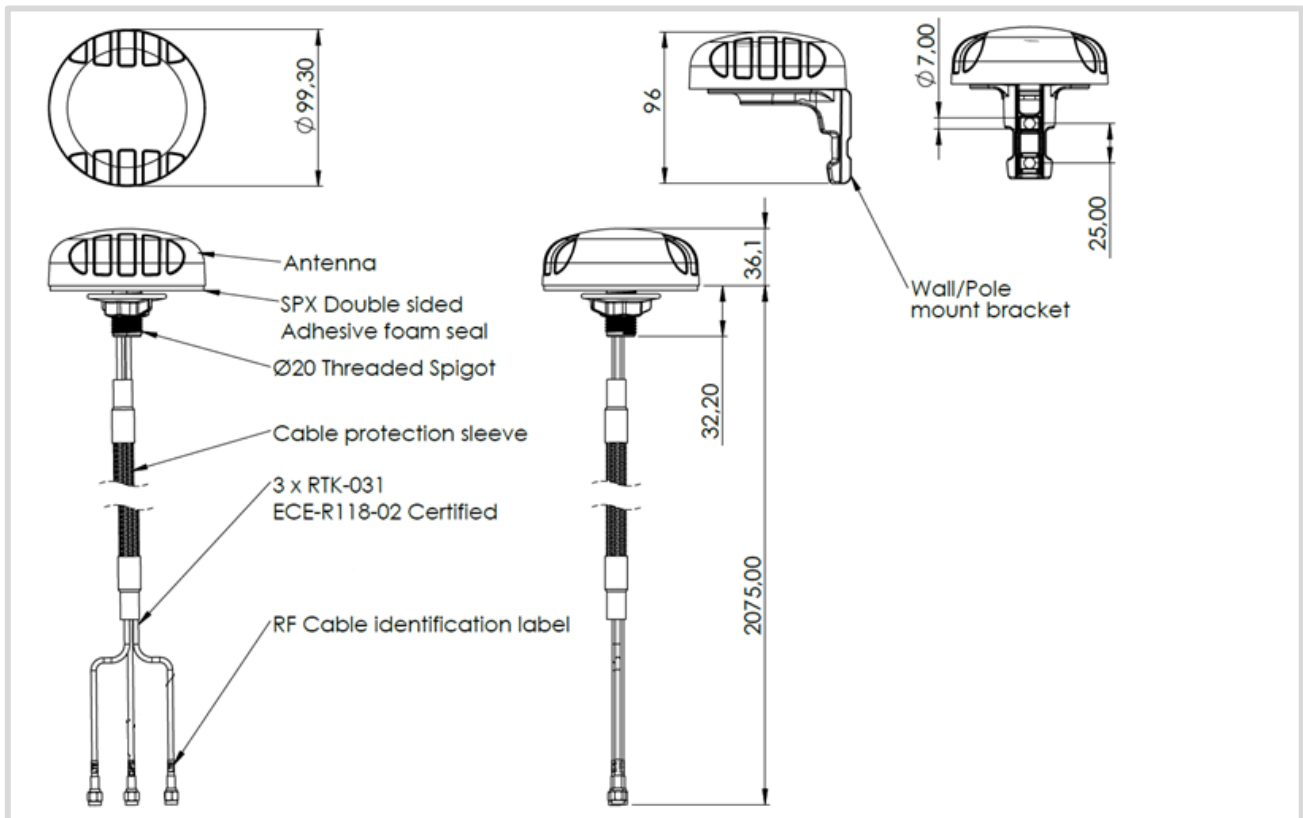

Radiation Patterns - Cellular

Azimuth: 617 – 968 MHz

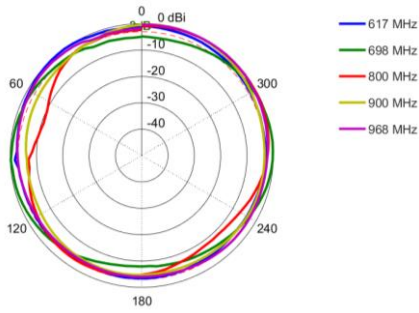

Azimuth: 1427 – 1517 MHz

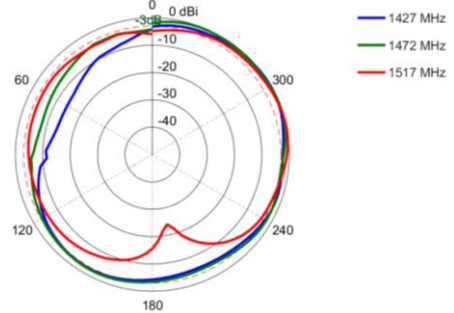

Azimuth: 1710 – 2170 MHz

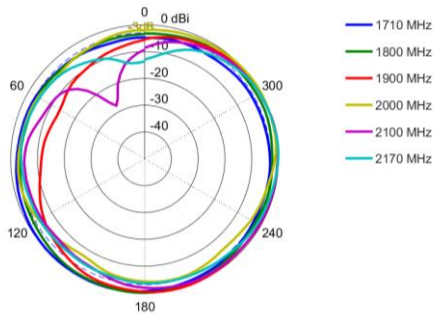

Azimuth: 2300 – 2700 MHz

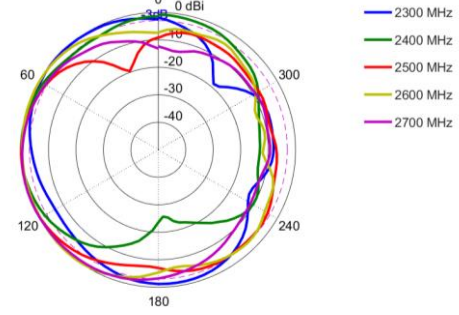

Azimuth: 3400 – 3800 MHz

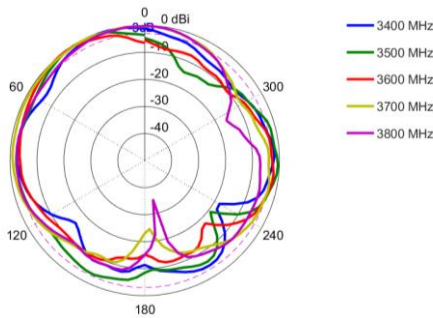

Azimuth: 4000 – 4200 MHz

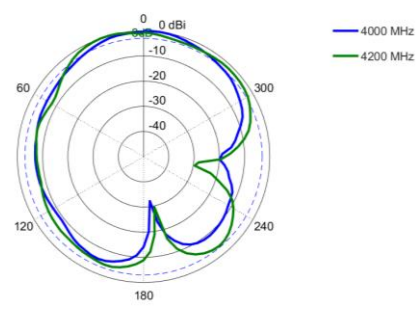

Elevation 1: 617 – 968 MHz

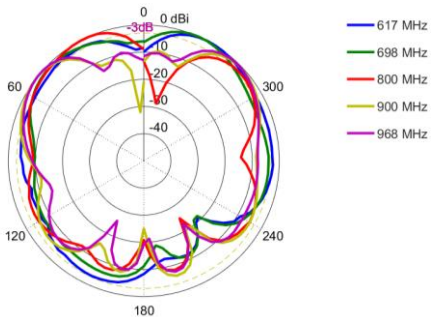

Elevation 1: 1427 – 1517 MHz

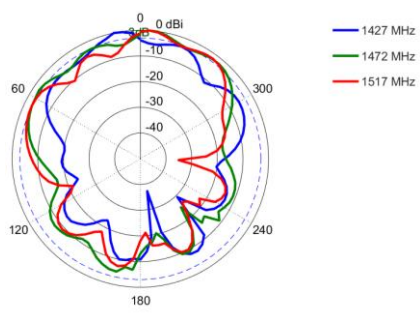

Elevation 1: 1710 – 2170 MHz

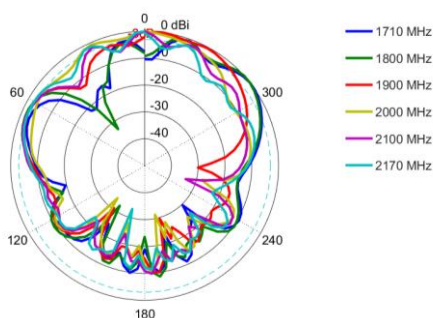

Elevation 1: 2300 – 2700 MHz

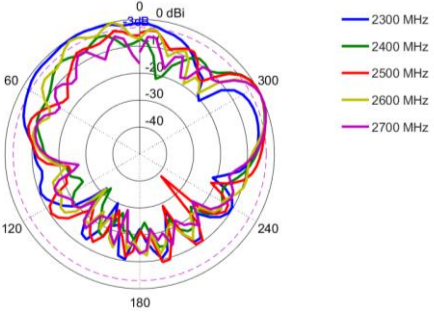

Elevation 1: 3400 – 3800 MHz

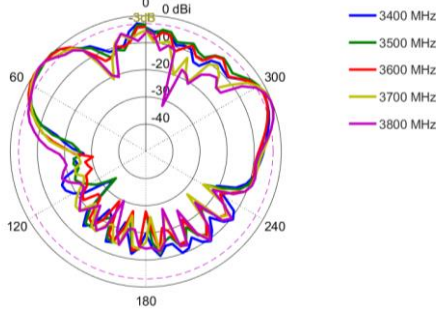

Elevation 1: 4000 – 4200 MHz

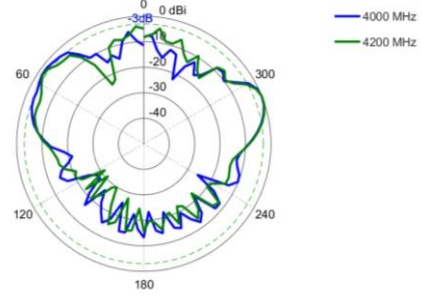

Elevation 2: 617 – 968 MHz

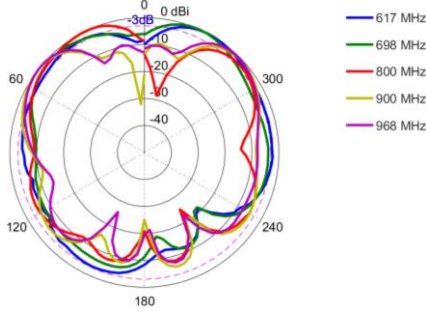

Elevation 2: 1427 – 1517 MHz

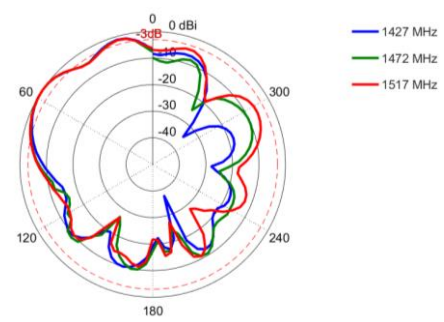

Elevation 2: 1710 – 2170 MHz

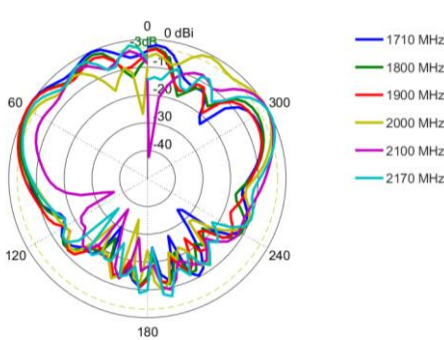

Elevation 2: 2300 – 2700 MHz

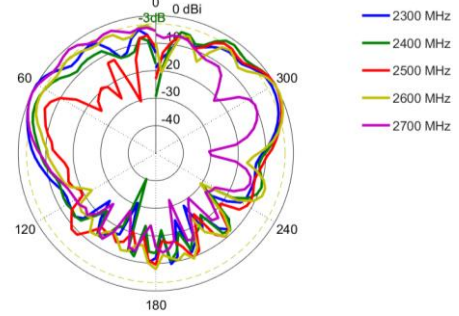

Elevation 2: 3400 – 3800 MHz

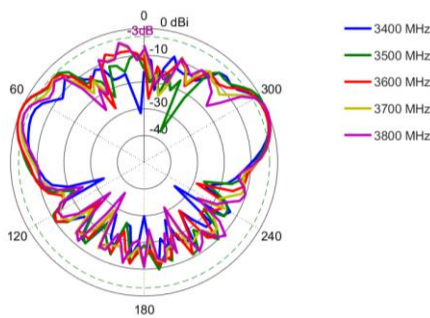

Elevation 2: 4000 – 4200 MHz

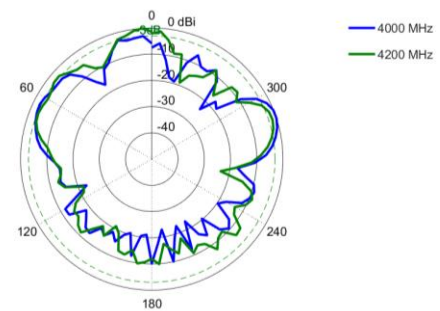

Radiation Patterns – GPS

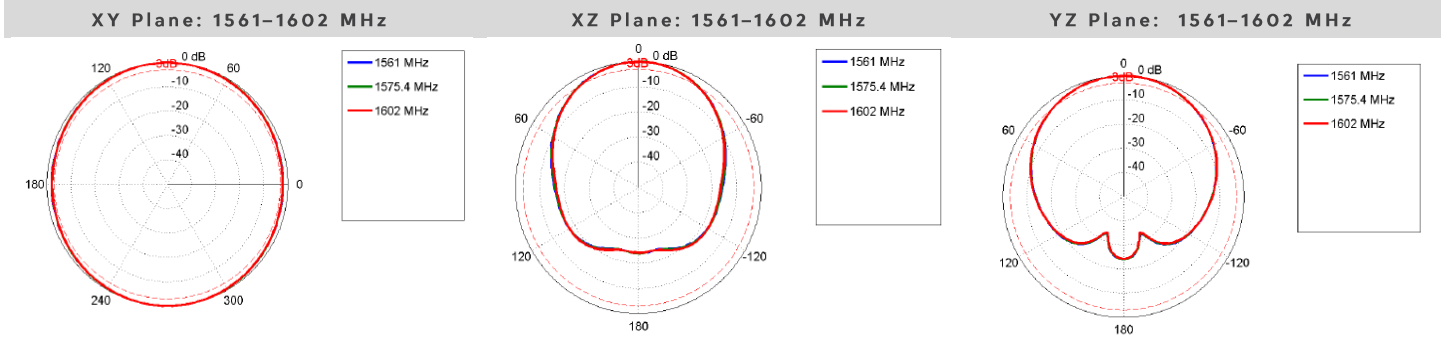

Mounting Options

Many Mounting Possibilities – included as standard

Poynting's new PUCK antenna range provides easy installation with the multiple mounting options. This includes as standard:

- Spigot Mount - two different lengths included (40mm & 80mm)
- Vertical Pole mount (inner & outer mounting for smaller and larger poles)
- Horizontal Pole Mount (e.g., marine rails)
- Magnetic Mount
- Surface Mount (Double Sided Tape)
- Wall Mount

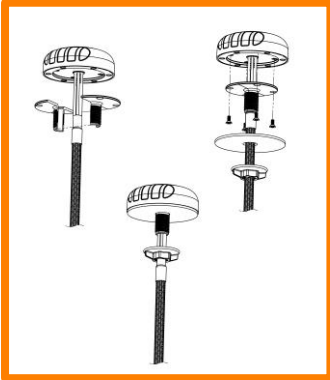

Spigot Mount

Removable 40mm & 80mm threaded spigot (included)

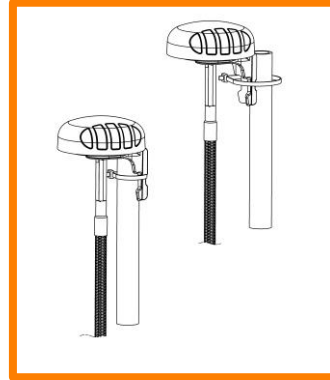

Vertical Pole Mount

Pole/Wall Mounting bracket (included)

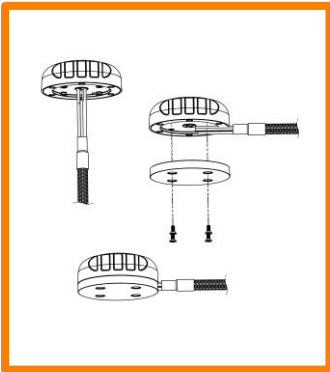

Magnetic Mount

Magnetic Base (included)
For temporary and low mobility installations.

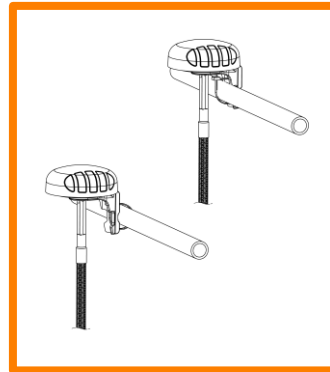

Horizontal Pole Mount

Pole/Wall Mounting bracket (included)

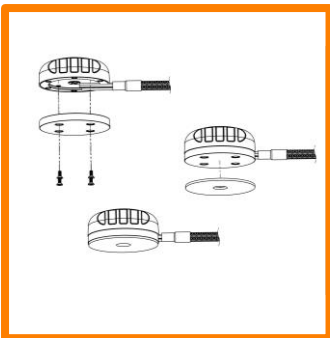

Surface Mount

Adhesive Surface Mounting (included) or can also be directly secured with longer M4 bolts (not included) to the female threaded inserts located in the antenna base

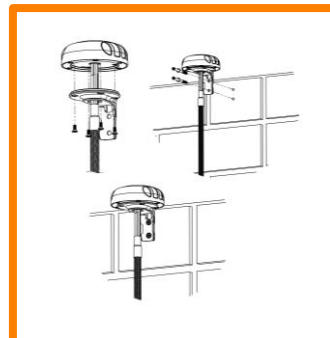

Wall Mount

Pole/Wall Mounting bracket (included)

Additional Accessories

See accessories technical specifications on www.poynting.tech



CONTACT POYNTING

Poynting Antennas (Pty) Ltd - Head Office

Unit 4, N1 Industrial Park,
Landmarks Avenue,
Samrand, 0157, South Africa

Phone: +27 (0) 12 657 0050

E-mail: info@poynting.tech

International Email: sales-global@poynting.tech

Poynting Europe

Regus Business Center Neue Messe Riem
Kronstadter Straße 4
81677 München
Germany

Phone: +49 89 7453 9002

E-mail: sales-europe@poynting.tech

Poynting USA

1804 Owen Court, Suite 104,
Mansfield,
TX 76063
USA

Phone: +1 817 533-8130

E-mail: sales-us@poynting.tech