













ANTENNAS | LPDA-92 SERIES

WIDEBAND LOG-PERIODIC DIPOLE ARRAY ANTENNA

698 - 3800 MHz, 11 dBi



					
698 – 960 MHz; 1427-1517 MHz; 1710 – 2700 MHz; 3400 – 3800 MHz	11 dBi	Increase x Mb/s	Uni-Directional	IoT	4G LTE
					
5G	2.4 - 2.5 GHz	3.5 GHz CBRS	IP 65	-40°C to +70°C	Fire Resistant



APPLICATION AREAS

- **Futureproof wideband LTE and Wi-Fi antenna covering 690 – 3800 MHz**
- **Compatible with 2G, 3G and 4G technologies**
- **5G Ready; includes 3.2 GHz to 3.8 GHz CBRS Band**
- **Improves mobile network subscriber's user experience**
- **Weather- and vandal resistant**
- **Used in extreme weather environment**

Product Overview

This high-gain, wideband, directional antenna covers all international cellular, mobile, and wireless data bands including GSM 900/ GSM1800/UMTS/LTE bands. It also covers the extended cellular and WiMAX bands such as European/USA "Digital Dividend bands" and 2.3- 2.7GHz licensed and unlicensed data bands. Its configuration is suitable for various wireless communications systems. This antenna is unique in its combination of ultra-wide-band operator with a consistent high-gain performance. It has been successfully used in extreme weather environments in Africa and Europe with close to zero failures. A firm favourite, in any area where operators are having signal challenges. It is ideal for any application using the GSM network (LTE/ HSPA/3G/EDGE/GPRS).

Features

- High gain directional antenna
- Easy alignment with main beam around 50° wide
- Broadband covering multiple operational frequencies
- Pole mountable
- Lightweight
- Water and dust resistant
- Tremendous improvement in reliability of wireless data
- Four-year track record in all climate conditions from snow to desert to tropical

Application Areas

- Urban and rural areas
- Antenna of choice for rural areas due to high gain
- Poor data signal reception (indoor or outdoor)
- Slow data transmission connection
- Unstable connection
- Increase system transmission reliability
- LTE fringe areas (close to an LTE area, but out of reach)
- Network operator flexibility – as the antennas are wideband, a new antenna is not needed per network operator – works on most networks



2 x LPDA-92 mounted for MIMO LTE
(using 1 x BRKT-30)

Frequency Bands

The LPDA-92 is a directional antenna that works from 698 – 960 MHz | 1427-1517 MHz | 1710 – 2700 MHz | 3400 –3800 MHz

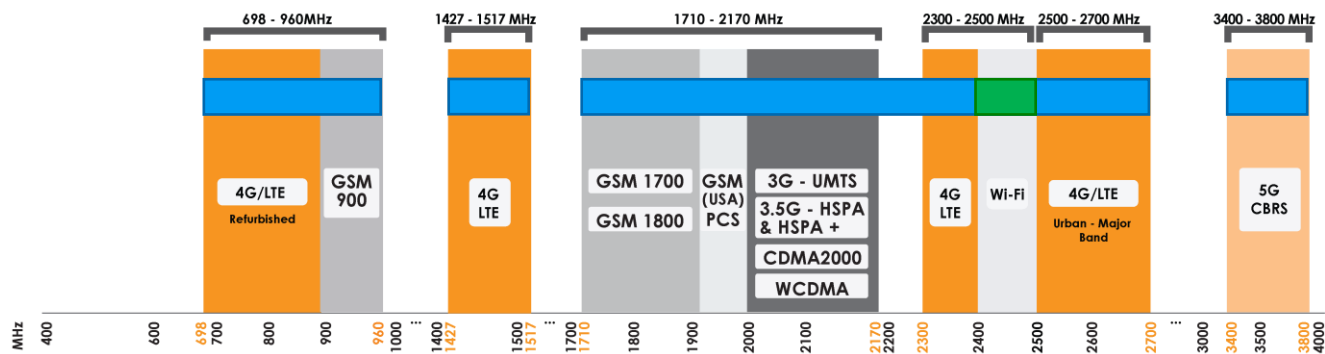

 Indicates the LTE bands on which LPDA-92 works

 Indicates the Wi-Fi bands on which LPDA-92 works

Antenna Derivatives

Product Order Code (SKU)	A-LPDA-0092	A-LPDA-0092-04	A-LPDA-0092-LTE	A-LPDA-0092-30-LTE
Ports/Antennas Included	1	1	2	2
Coax Cable Type	HDF 195	HDF 195	HDF 195	HDF 195
Coax Cable Length	7m	0.3 m	7m	7m
Connector Type	SMA (M)	N-Type (F)	SMA (M)	SMA (M)
Included Mounting Bracket	N/A	N/A	A-BRKT-033	A-BRKT-030
Antenna Unit Weight	1.63 Kg	1.55 Kg	1.63 Kg	1.63 Kg
Bracket Weight	N/A	N/A	990 g	293 g
Antenna Dimensions	1112 x 200 x 47 mm	1112 x 200 x 47 mm	1112 x 200 x 47 mm	1112 x 200 x 47 mm
Bracket Dimensions	N/A	N/A	414 x 166 x 120 mm	127 x 100 x 97 mm
Packaged Weight	2.02 Kg	1.94 Kg	5.01 Kg	4.46 Kg
Packaged Dimensions	1120 x 210 x 60 mm	1120 x 210 x 60 mm	Quantity Dependent	Quantity Dependent
EAN	6009693810556	6009710924655	6009710921166	6009710921180

Electrical Specifications

Frequency bands:	698 – 960 MHz 1427-1517 MHz 1710 – 2700 MHz 3400 –3800 MHz
Gain (max):	10.8 dBi @ 698-960 MHz 10 dBi @ 1427-1517 MHz 11 dBi @ 1710-2700 MHz 2.3 dBi @ 3400-3800 MHz
VSWR:	<1.5:1 across 95% of the bands
Feed power handling:	10 W
Input impedance:	50 Ohm (nominal)
Polarisation:	directional Linear
Coax cable loss:	0.385 dB/m @ 900 MHz 0.507 dB/m @ 1500 MHz 0.565 dB/m @ 1800 MHz 0.666 dB/m @ 2400 MHz 0.788 dB/m @3000 MHz
DC short:	Yes

Product Box Contents

Antenna:	A-LPDA-0092
Mounting bracket:	Econo brackets, U-bolts, and fasteners suitable for pole mounting

Mechanical Specifications

Plastics material:	Nylon 6
Plastics colour:	Black
Frame material:	Passivated ADC12
Frame colour:	Aluminium grey
Mounting Type:	Pole Mount

Environmental Specifications, Certification & Approvals

Wind Survival:	≤160 km/h
Temperature Range (Operating):	-40°C to +70°C
Environmental Conditions:	Outdoor/Indoor
Water ingress protection ratio/standard:	IP 65
Salt Spray:	MIL-STD 810F/ASTM B117
Operating Relative Humidity:	Up to 98%
Storage Humidity:	5% to 95% - non-condensing
Storage Temperature:	-40°C to +70°C
Enclosure Flammability Rating:	UL 94-HB
Impact resistance:	IK 08
Product Safety & Environmental:	Complies with CE and RoHS standards



Antenna Performance Plots

VSWR

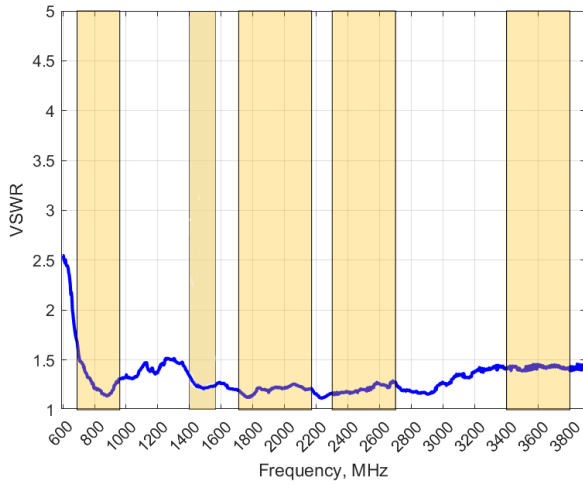

GAIN (EXCLUDING CABLE LOSS)

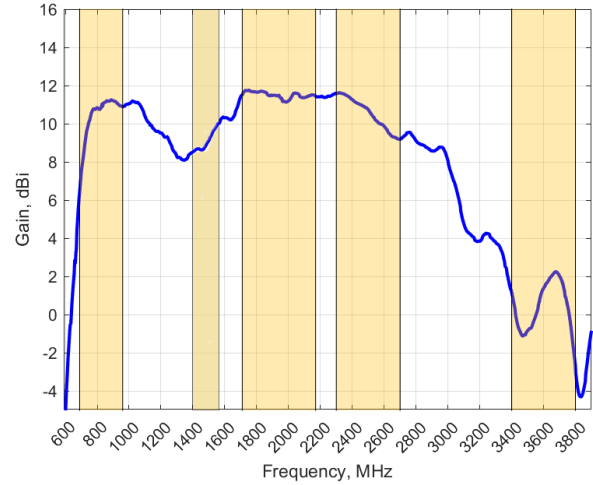

Voltage Standing Wave Ratio (VSWR)*

VSWR is a measure of how efficiently radio-frequency power is transmitted from a power source, through a transmission line, into a load. In an ideal system, 100% of the energy is transmitted which corresponds to a VSWR of 1:1.

The LPDA-92 delivers superior performance across all bands with a VSWR of <1.5:1 across 95% of the bands.

*VSWR measured with 5m low loss cable.

Gain* in dBi

11 dBi is the peak gain across all bands from 698 – 3800 MHz

Gain @ 698 – 960 MHz:	10.8 dBi
Gain @ 1427-1517 MHz	10 dBi
Gain @ 1710 – 2700 MHz:	11 dBi
Gain @ 3400 –3800 MHz:	2.3 dBi

*Antenna gain measured with polarisation aligned standard antenna

Technical Drawings

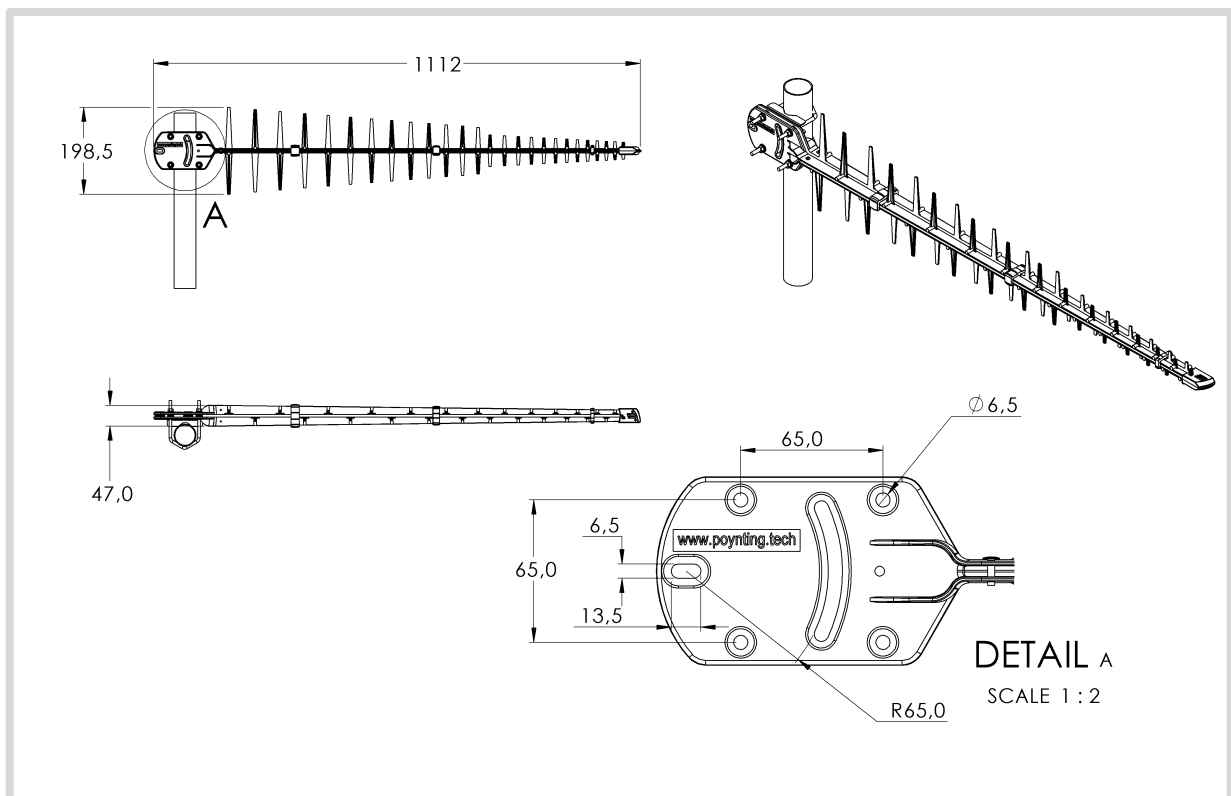

Radiation Patterns

Azimuth: 690 – 960 MHz

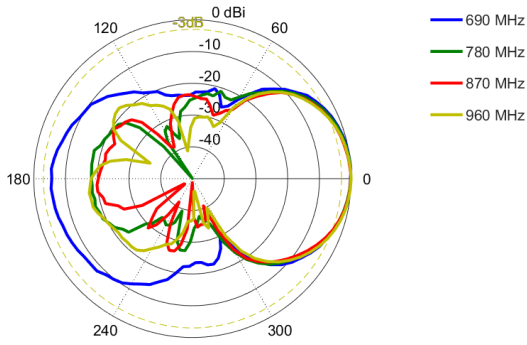

Azimuth: 1710 – 2170 MHz

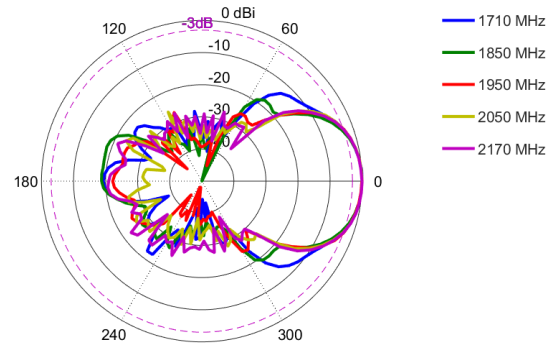

Azimuth: 2170 – 2700 MHz

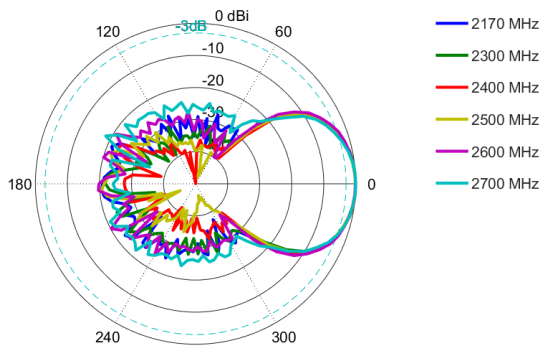

Azimuth: 3400 – 3800 MHz

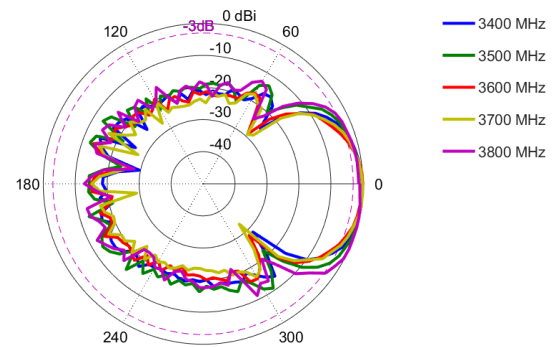

Elevation: 690 – 960 MHz

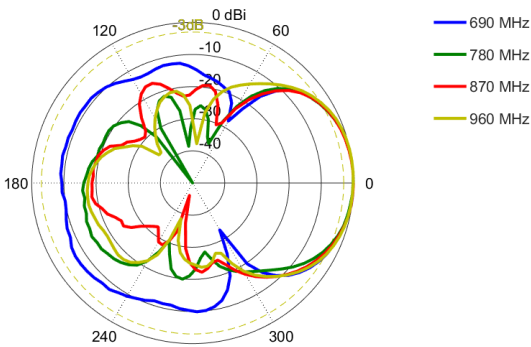

Elevation: 1710 – 2170 MHz

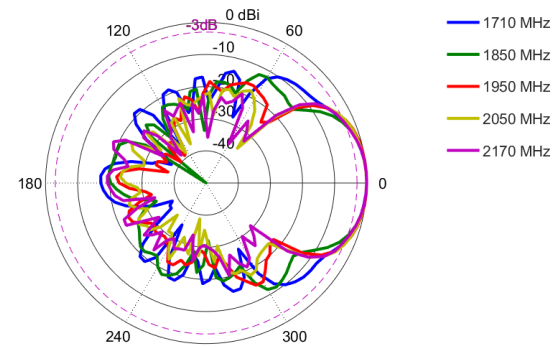

Elevation: 2170 – 2700 MHz

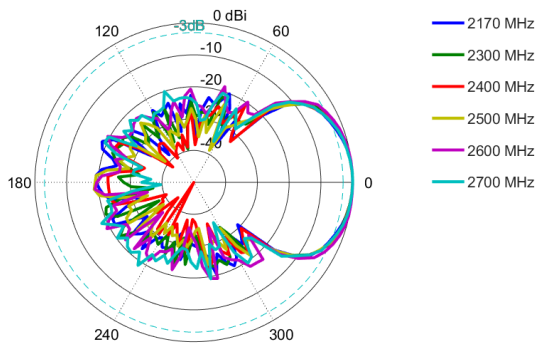

Elevation: 3400 – 3800 MHz

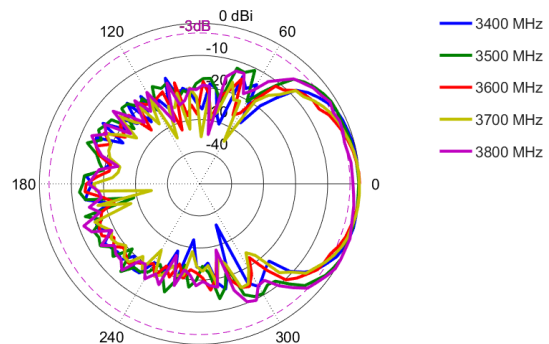

Mounting Options

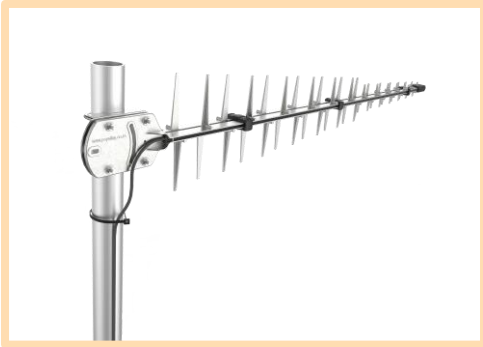

Pole Mount

Pole mounted vertically using U-bolts



A-LPDA-0092-30-LTE Mount

Pole mounted vertically and horizontally using U-bolts and a BRKT-030



A-LPDA-0092-LTE Mount

Pole mounted at $\pm 45^\circ$ using U-bolts and a BRKT-033

Additional Accessories

Extension Cables: Up to 10m HDF 195
Various connectors available
Installation poles and brackets available

See accessories technical specifications on www.poynting.tech

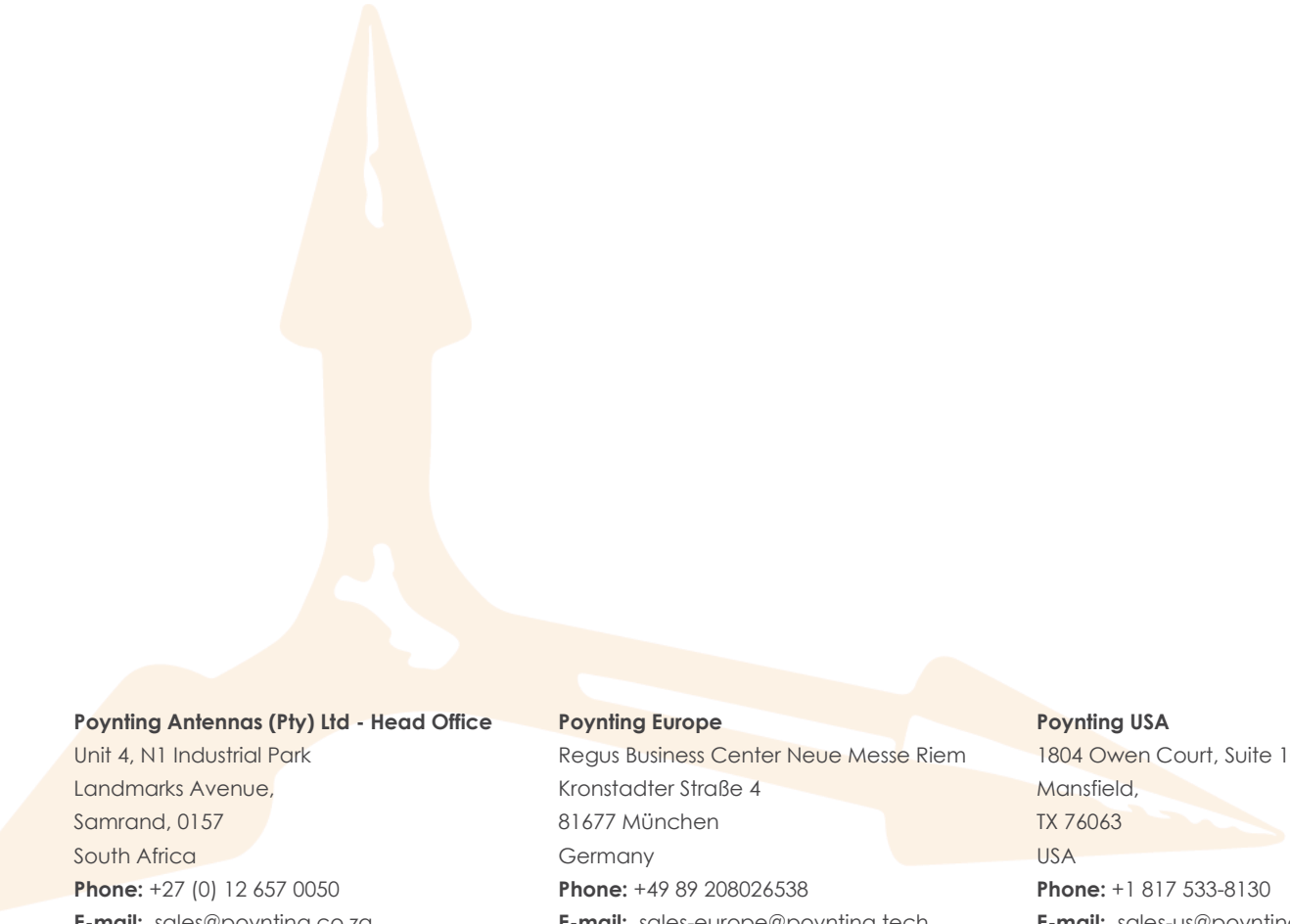

Poynting Antennas (Pty) Ltd - Head Office

Unit 4, N1 Industrial Park
Landmarks Avenue,
Samrand, 0157
South Africa

Phone: +27 (0) 12 657 0050

E-mail: sales@poynting.co.za

Poynting Europe

Regus Business Center Neue Messe Riem
Kronstadter Straße 4
81677 München
Germany

Phone: +49 89 208026538

E-mail: sales-europe@poynting.tech

Poynting USA

1804 Owen Court, Suite 104,
Mansfield,
TX 76063
USA

Phone: +1 817 533-8130

E-mail: sales-us@poynting.tech